



ORELL

SUCTION FILTERS SD



MATERIALS

Cover & housing:
Anodized aluminium alloy

For 61&62 only:
Cover: anodized aluminium alloy
Housing: steel

Bypass valve:
Polyamide

Seals:
NBR Nitrile
(FKM on request fluoroelastomer)

Indicator housing:
Brass

PRESSURE (ISO 10771-1:2002)

Collapse, differential
for the filter element (ISO 2941):
1 MPa (10 bar)

BYPASS VALVE

Setting:
35 kPa (0,35 bar) \pm 10%

WORKING TEMPERATURE

From -25° to +110° C

COMPATIBILITY (ISO 2943:1999)

Full with fluids:
HH-HLHM-HV-HTG
(according to ISO 6743/4)
For fluids different than the above
mentioned, please contact our
Sales Department.

APPLICATION EXAMPLE

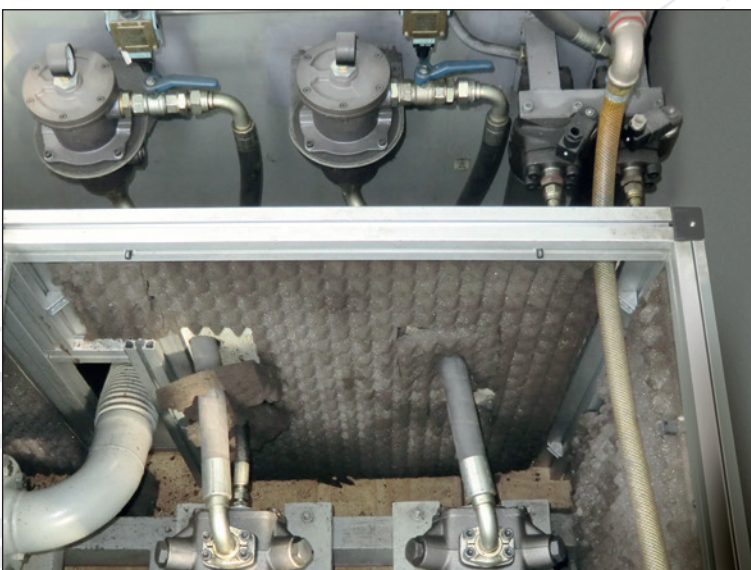

OHF 220

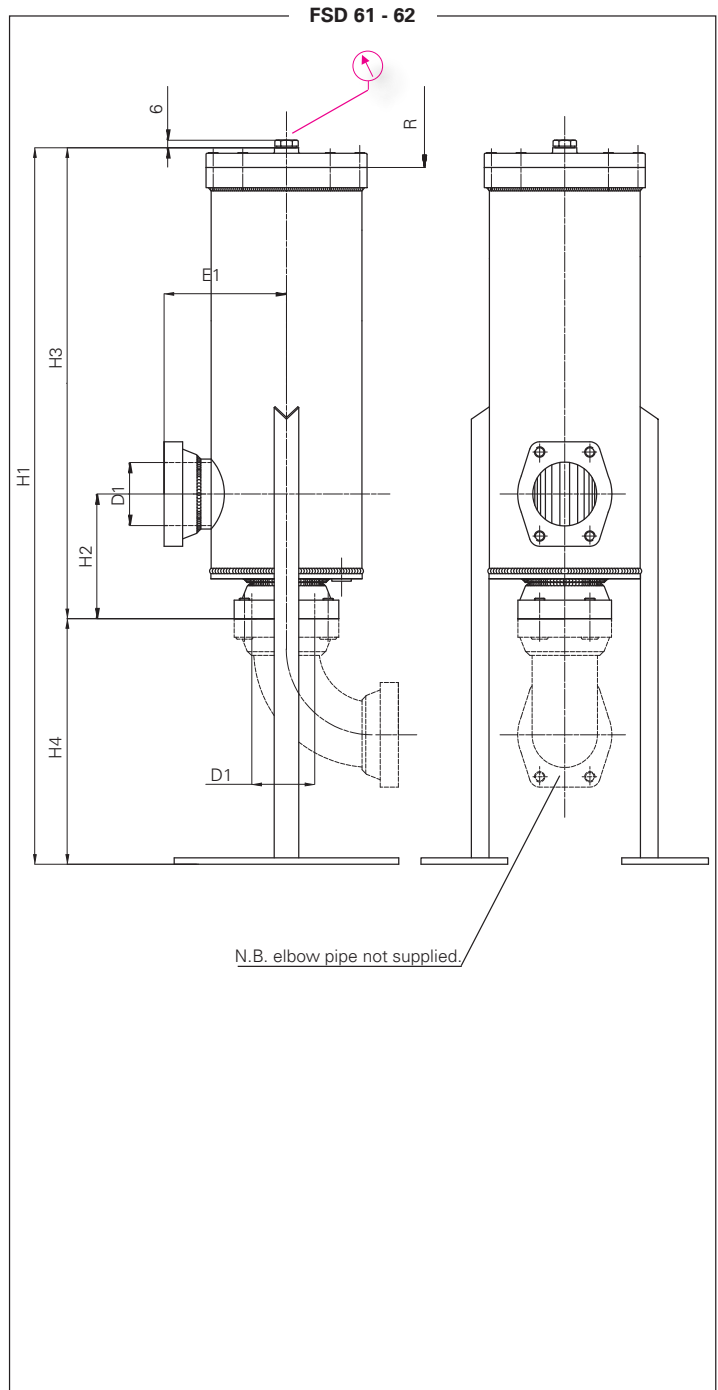
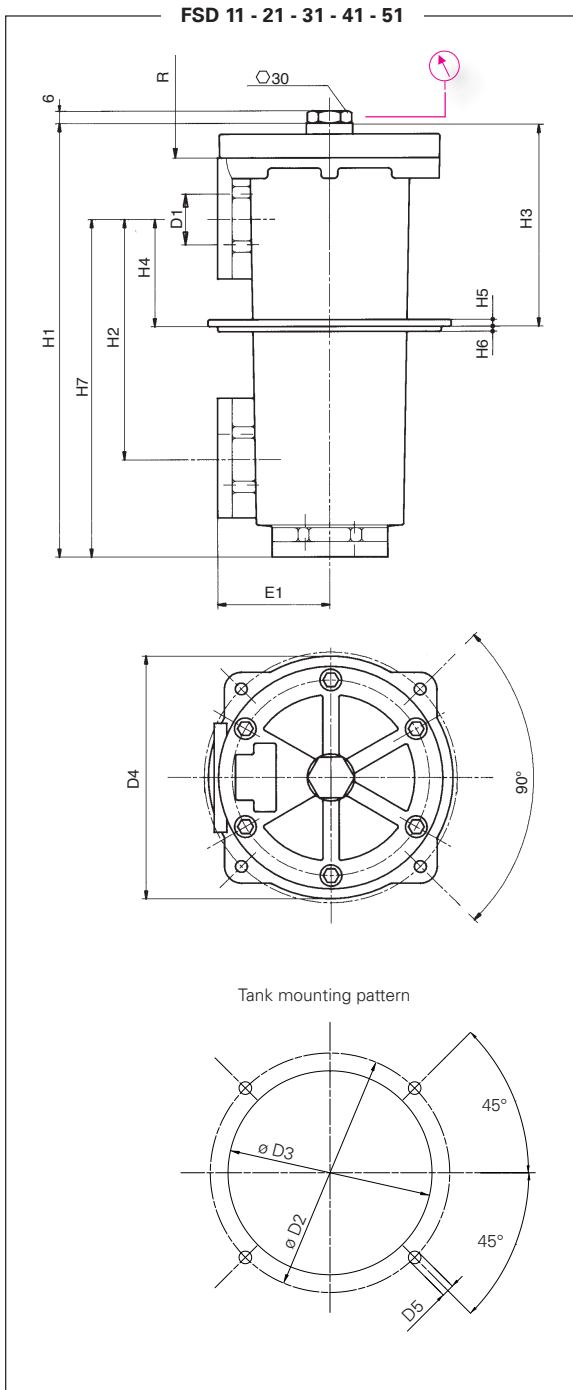

FILTER HOUSING														
	D1	D2	D3	D4	D5	E1	H1	H2	H3	H4	H5	H6	R	kg
FSD11	1/2"	95	85	90	M5	43	160	62,5	96	31,5	4	3	105	1,3
FSD21	3/4"	138	123	128	M6	57	191	105	100	52	6	3	110	2,6
FSD31	1"	154	137	147	M6	67	250	140	117	63	8	4	155	3,7
FSD41	1" 1/2	180	164	174	M8	82	323	177	155	82	8	4	240	6,5
FSD51	2" 1/2	275	239	254	M10	117,5	420	218	192	91	10	8	275	14,2
FSD61	3" 1/2	-	-	-	-	178	1.130	200	673	457	-	-	525	49,0
FSD62	4"	-	-	-	-	178	1.590	200	1.110	480	-	-	1.020	75,0

		TYPE									
		F = FILTER COMPLETE									
		B = FILTER HOUSING								ELEMENT	
S	D									E	
		FAMILY NOMINAL SIZE & LENGTH								FAMILY SIZE & LENGTH	
		11	21	31	41	51	61	62	R	D	
		PORT TYPE									
		B = BSP thread									
		N = NPT thread									
		S = SAE thread									
		F = SAE flange 3000 psi, metric screws									
		PORT SIZE									
		04 = 1/2"									
		06 = 3/4"									
		08 = 1"									
		12 = 1" 1/2									
		20 = 2" 1/2									
		28 = 3" 1/2									
		32 = 4"									
		BYPASS VALVE									
		W = without									
		A = 35 kPa (0,35 bar)									
		SEALS								SEALS	
		N = NBR Nitrile								N = NBR	
		F = FKM Fluoroelastomer								F = FKM	
		FILTER MEDIA								FILTER MEDIA	
		ME = metal wire mesh 60 µm								ME=w. mesh 60 µm	
		MF = metal wire mesh 90 µm								MF= w. mesh 90 µm	
		MG = metal wire mesh 250µm								MG=w. mesh 250µm	
		CLOGGING INDICATOR									
		08 = 1/8" seat, plugged									
		11 = vacuum gauge, bottom connection									
		91 = SPDT, vacuum switch									
X	X	ACCESSORIES									
		XX = no accessory available									

FILTER ELEMENT					
	A	B	C	kg	Area (cm ²) Media M+
ERD11	52	28/24	70	0,10	245
ERD21	70	34	85	0,20	460
ERD31	70	34	130	0,25	740
ERD41	99	51	211	0,70	2.330
ERD51	130	74	251	1,50	3.340
ERD61	130	74/85	500	2,00	9.860
ERD62	143	96,3	896	3,80	22.000

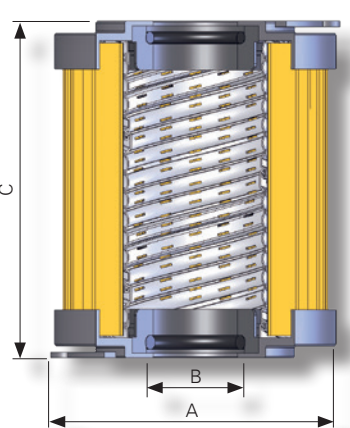

FLUID SPEED

when selecting the filter size, we suggest to consider also the max recommended fluid speed (in suction lines normally $0,1 < v < 1$ m/s)

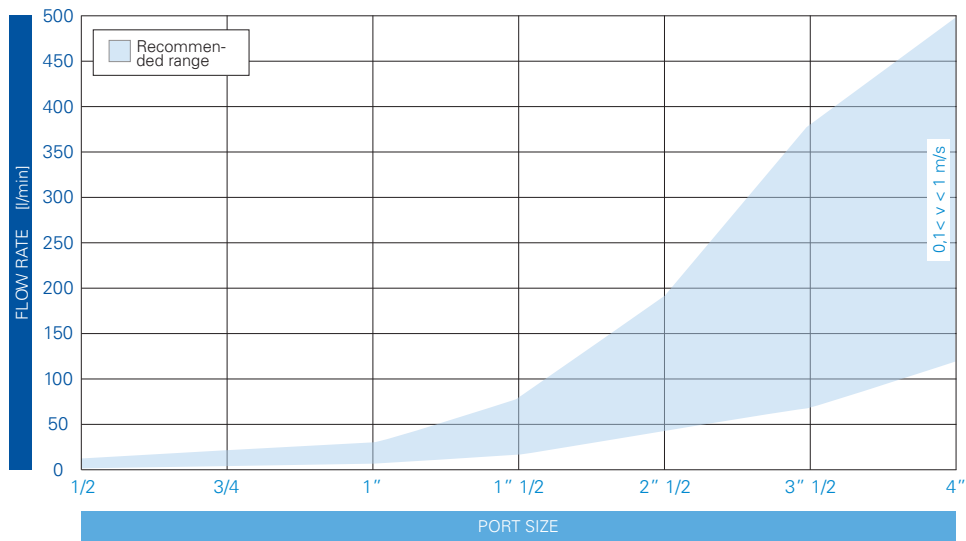

PRESSURE DROP CURVES (Δp)

The "Assembly Pressure Drop (Δp)" is obtained by adding the pressure drop values of the Filter Housing and of the Clean Filter Element corresponding to the considered Flow Rate and it must be lower than 3 kPa (0,03 bar).

FILTER HOUSING PRESSURE DROP

(mainly depending on the port size)

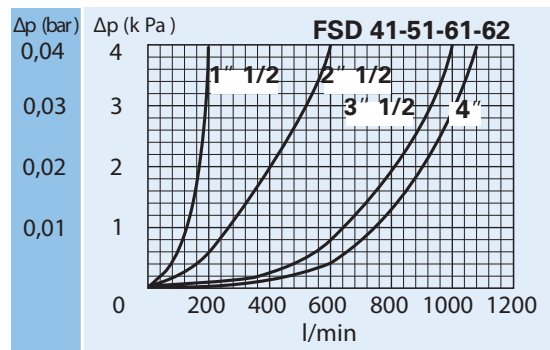
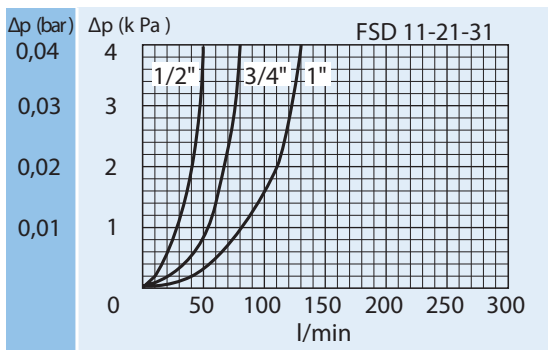

CLEAN FILTER ELEMENT PRESSURE DROP WITH ME MEDIA

(depending both on the internal diameter of the element and on the filter media)

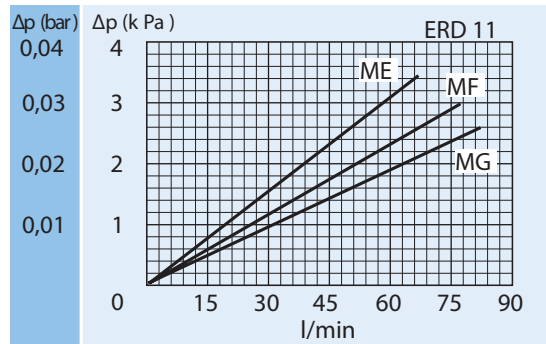

CLEAN FILTER ELEMENT PRESSURE DROP WITH M+ MEDIA
 (depending both on the internal diameter of the element and on the filter media)

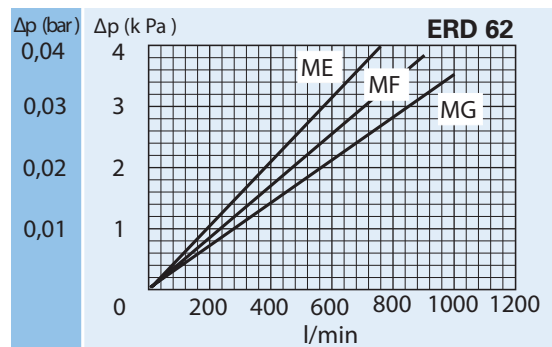
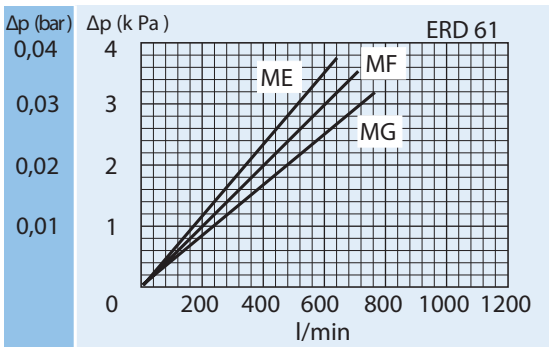
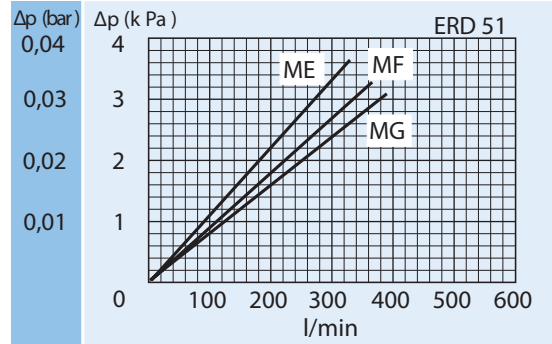
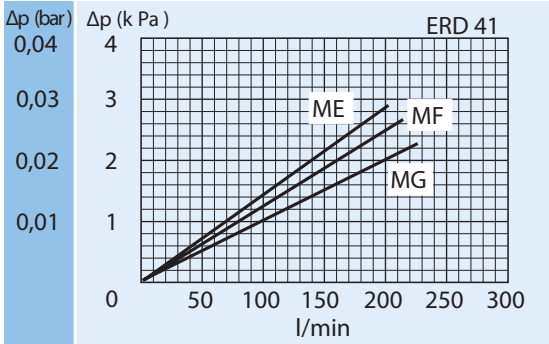
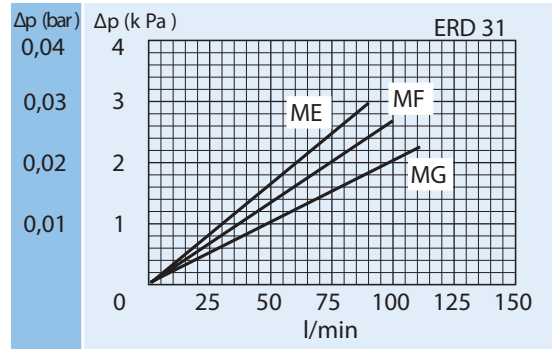
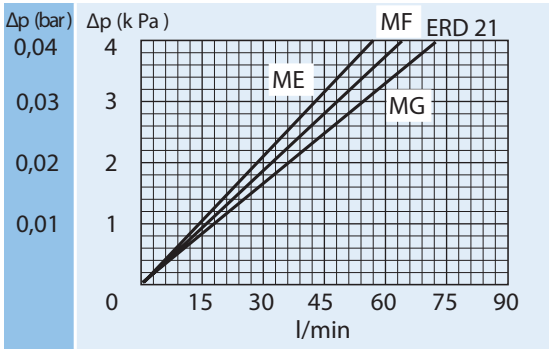

BYPASS VALVE PRESSURE DROP

When selecting the filter size, these curves must be taken into account if it is foreseen that any flow peak is to be absorbed by the bypass valve, it also must be of proper configuration to avoid pressure peaks. The valve pressure drop is directly proportional to fluid specific gravity.

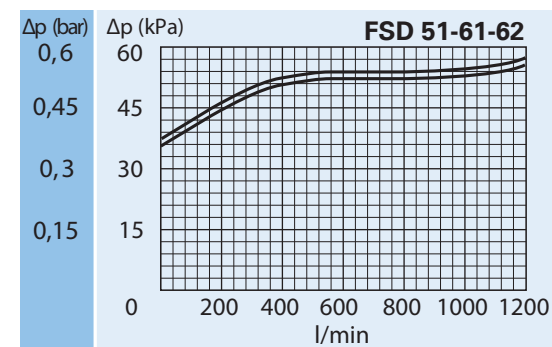
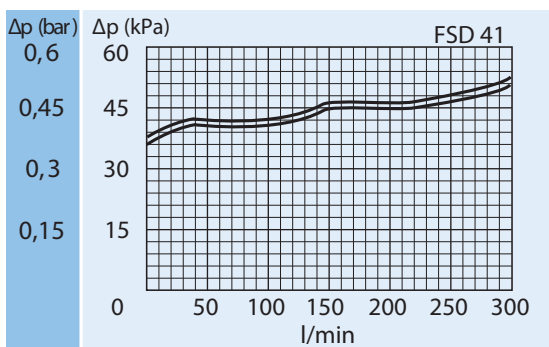
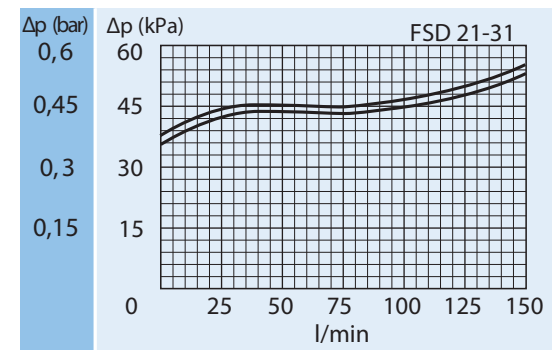
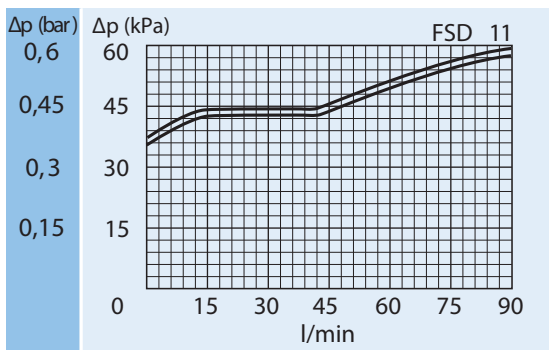

CLOGGING INDICATOR

A visual or electrical indicator allows monitoring of the element condition, and gives an indication of the proper time for replacement. The port for the indicator is a standard feature.

STRONG CONSTRUCTION

The strong filter housing makes the FSD filters particularly suitable for applications where each component must provide the highest reliability.

FLEXIBILITY OF ASSEMBLING

A second inlet port, supplied plugged, permits you to easily solve special installation needs.

CLOGGING INDICATOR

For further technical informations and other options see page 187.



NO LEAKS

The end caps with captive O-ring ensure a perfect sealing between filter element and housing.

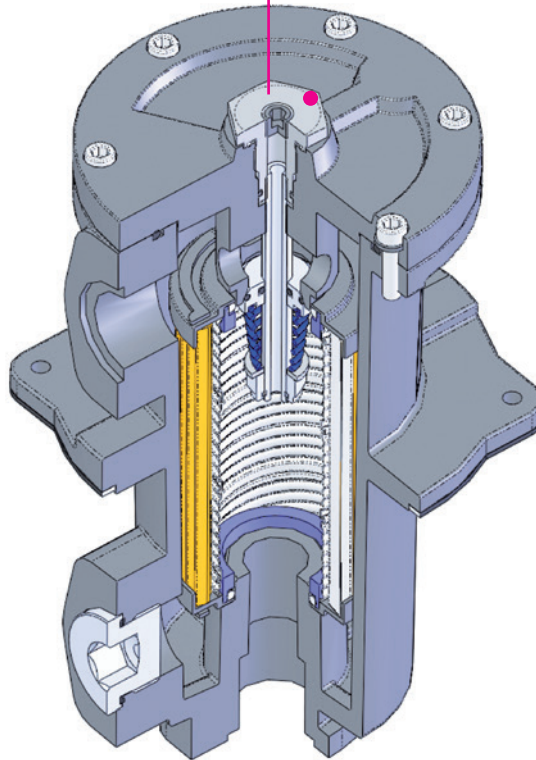

SPARE SEAL KIT

	NBR	FKM
FSD11	521.0045.2	521.0050.2
FSD21	521.0046.2	521.0051.2
FSD31	521.0047.2	521.0052.2
FSD41	521.0031.2	521.0019.2
FSD51	521.0048.2	521.0053.2
FSD61	521.0049.2	521.0054.2
FSD62	521.0049.2	521.0094.2

FILTER HOUSING

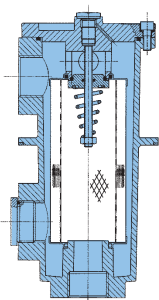

B | S | D | | | | | | | | | | X | X

FILTER ELEMENT

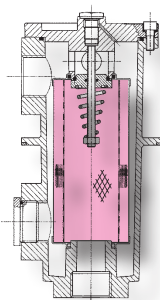

E | R | D | | | | | | | | | |

CLOGGING INDICATOR

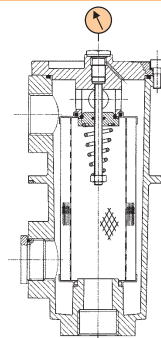

| |

SPARE PARTS ELEMENTS
(For filling up see table "Ordering and option chart")

Technical data subject to variations without prior notice. SD - EN - 03/2011