



**ORELL**

# PRESSURE FILTERS PB



## MATERIALS

Head:  
Cast iron

Bowl:  
Steel

Bypass valve:  
Steel

Seals:  
NBR Nitrile  
(FKM - on request fluoro-  
elastomer)

Indicator housing:  
Brass

## PRESSURE (ISO 10771-1:2002)

Max. working: 42 MPa (420 bar)

Test: 62 MPa (620 bar)

Bursting: 126 MPa (1.260 bar)

Collapse, differential  
for the filter element (ISO  
2941):  
series standard 2 MPa (20 bar)  
serie H+ 21 MPa (210 bar)

## APPLICATION EXAMPLE



## BYPASS VALVE

Setting:  
600 kPa (6 bar)  $\pm$  10%

## WORKING TEMPERATURE

From -25° to +110° C

## COMPATIBILITY (ISO 2943:1999)

Full with fluids:  
HH-HL-HM-HV-HTG  
(according to ISO 6743/4)  
For fluids different than the above  
mentioned, please contact our  
Sales Department.

**OHF 310**

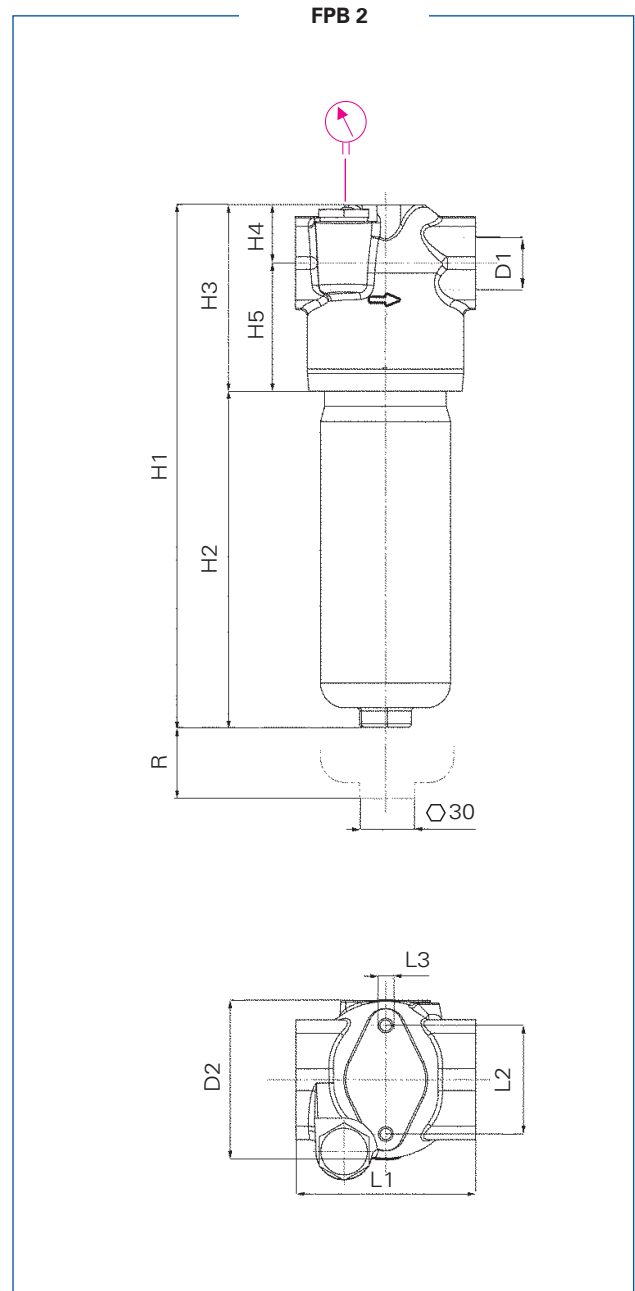
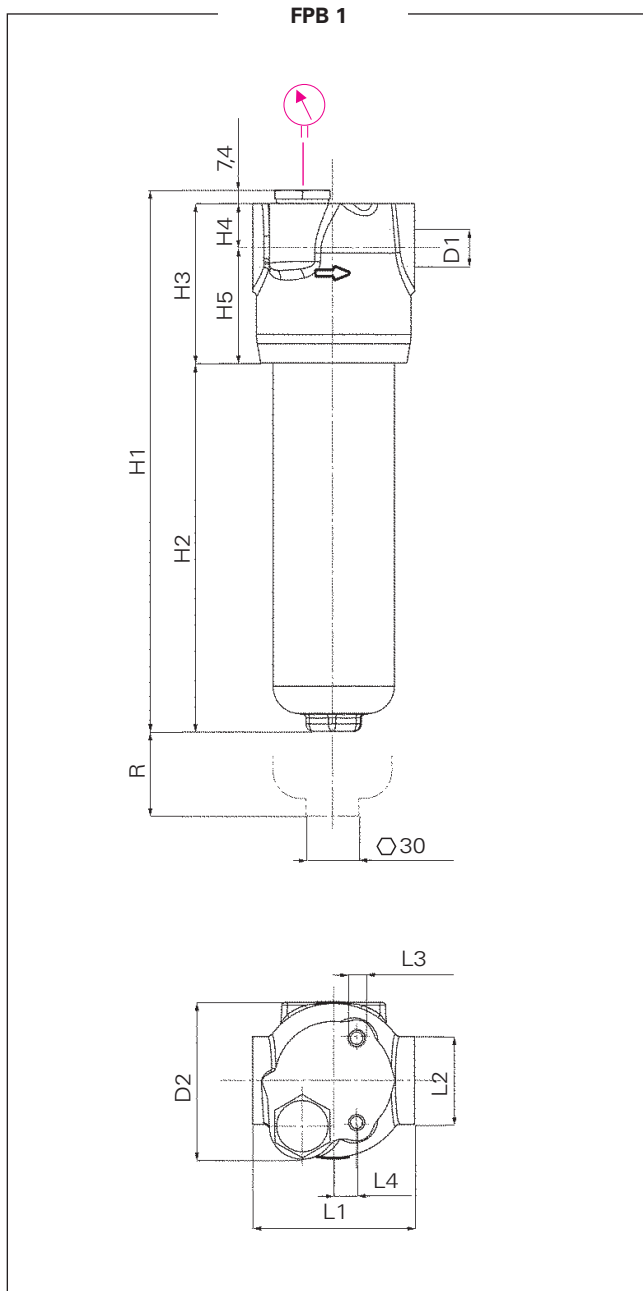

## FILTER HOUSING

	D1	D2	H1	H2	H3	H4	H5	L1	L2	L3	L4	R	kg
FPB11	1/2" - 3/4"	86	166	79	87	24	63	88	46	M8	12,5	100	4,4
FPB12	1/2" - 3/4"	86	196	109	87	24	63	88	46	M8	12,5	100	4,6
FPB13	1/2" - 3/4"	86	296	209	87	24	63	88	46	M8	12,5	100	5,2
FPB21	3/4" - 1"	94	226	116	112	35	77	108	65	M8	-	100	6,6
FPB22	3/4" - 1"	94	317	207	112	35	77	108	65	M8	-	100	8,2

		<b>TYPE</b>						
		F = FILTER COMPLETE	F	F	F	F	F	
		B = FILTER HOUSING	B	B	B	B	B	<b>ELEMENT</b> E
<b>P</b>	<b>B</b>	<b>FAMILY, SIZE &amp; LENGTH</b>					<b>FAMILY SIZE &amp; LENGTH</b> P B	
			11	12	13	21	22	
		<b>PORT TYPE</b>						
		B = BSP - thread	B	B	B	B	B	
		N = NPT - thread	N	N	N	N	N	
		S = SAE - thread	S	S	S	S	S	
		F = SAE Flange 3000 psi	-	-	-	F	F	
		G = SAE Flange 6000 psi	-	-	-	G	G	
		<b>PORT SIZE</b>						
		04 = 1/2" (N04 not available)	04	04	04	-	-	
		06 = 3/4"	06	06	06	06	06	
		08 = 1" (G08 not available; F08 for PB2+ only)	-	-	-	08	08	
		<b>BYPASS VALVE</b>						
		W = without	W	W	W	W	W	} on request only
		C = 600 kPa (6 bar)	C	C	C	C	C	
		R = reverse flow valve	-	-	-	R	R	
		P = reverse flow + bypass valve	-	-	-	P	P	
		<b>SEALS</b>					<b>SEALS</b>	
		N = NBR Nitrile	N	N	N	N	N	N = NBR
		F = FKM Fluoroelastomer	F	F	F	F	F	F = FKM
		<b>FILTER MEDIA</b>					<b>FILTER MEDIA</b>	
		FA = fiber 5 μm <sub>(c)</sub> β>1.000 Δp 2MPa (20 bar)	FA	FA	FA	FA	FA	FA = fib. 5 μm <sub>(c)</sub> 20 bar
		FB = fiber 7 μm <sub>(c)</sub> β>1.000 Δp 2MPa (20 bar)	FB	FB	FB	FB	FB	FB = fib. 7 μm <sub>(c)</sub> 20 bar
		FC = fiber 12 μm <sub>(c)</sub> β>1.000 Δp 2MPa (20 bar)	FC	FC	FC	FC	FC	FC = fib. 12 μm <sub>(c)</sub> 20 bar
		FD = fiber 21 μm <sub>(c)</sub> β>1.000 Δp 2MPa (20 bar)	FD	FD	FD	FD	FD	FD = fib. 21 μm <sub>(c)</sub> 20 bar
		HA = fiber 5 μm <sub>(c)</sub> β>1.000 Δp 21MPa (210 bar)	HA	HA	HA	HA	HA	HA = fib. 5 μm <sub>(c)</sub> 210 bar
		HB = fiber 7 μm <sub>(c)</sub> β>1.000 Δp 21MPa (210 bar)	HB	HB	HB	HB	HB	HB = fib. 7 μm <sub>(c)</sub> 210 bar
		HC = fiber 12 μm <sub>(c)</sub> β>1.000 Δp 21MPa (210 bar)	HC	HC	HC	HC	HC	HC = fib. 12 μm <sub>(c)</sub> 210 bar
		HD = fiber 21 μm <sub>(c)</sub> β>1.000 Δp 21MPa (210 bar)	HD	HD	HD	HD	HD	HD = fib. 21 μm <sub>(c)</sub> 210 bar
		CC = cellulose 10 μm β>2 Δp 2MPa (20 bar)	CC	CC	CC	CC	CC	CC = cel. 10 μm 20 bar
		<b>CLOGGING INDICATORS</b>						
		03 = port, plugged	03	03	03	03	03	When the filter is ordered with FKM seals, the first digit of the indicator code is a letter (please see page 182 - 183).
		5E = visual differential 500 kPa (5 bar)	5E	5E	5E	5E	5E	
		5F = visual differential 800 kPa (8 bar)	5F	5F	5F	5F	5F	
		6E = electrical differential 500 kPa (5 bar)	6E	6E	6E	6E	6E	
		6F = electrical differential 800 kPa (8 bar)	6F	6F	6F	6F	6F	
		7E = indicator 6E with LED	7E	7E	7E	7E	7E	
		7F = indicator 6F with LED	7F	7F	7F	7F	7F	
		T2 = elect. diff. 500 kPa (5 bar) with thermostat 30°C	T2	T2	T2	T2	T2	
		T3 = elect. diff. 800 kPa (8 bar) with thermostat 30°C	T3	T3	T3	T3	T3	
<b>X</b>	<b>X</b>	<b>ACCESSORIES</b>						
		XX = no accessory available	XX	XX	XX	XX	XX	N.B. Indicator series 72 & 73 only on request

**FILTER ELEMENT**

	A	B	C	kg media F+&C+	kg media H+	Area (cm <sup>2</sup> )		
						Media F+	Media H+	Media C+
EPB11	45	25	85	0,15	0,25	355	340	310
EPB12	45	25	116	0,20	0,55	500	475	435
EPB13	45	25	211	0,30	0,45	935	915	815
EPB21	52	23,5	115	0,25	0,40	975	975	780
EPB22	52	23,5	210	0,35	0,55	1.830	1.785	1.465

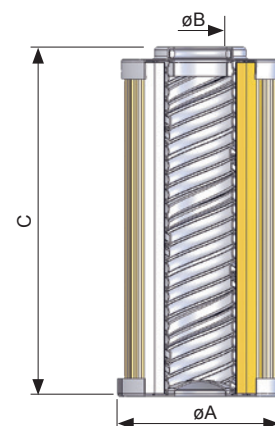

FPB 31-32-33

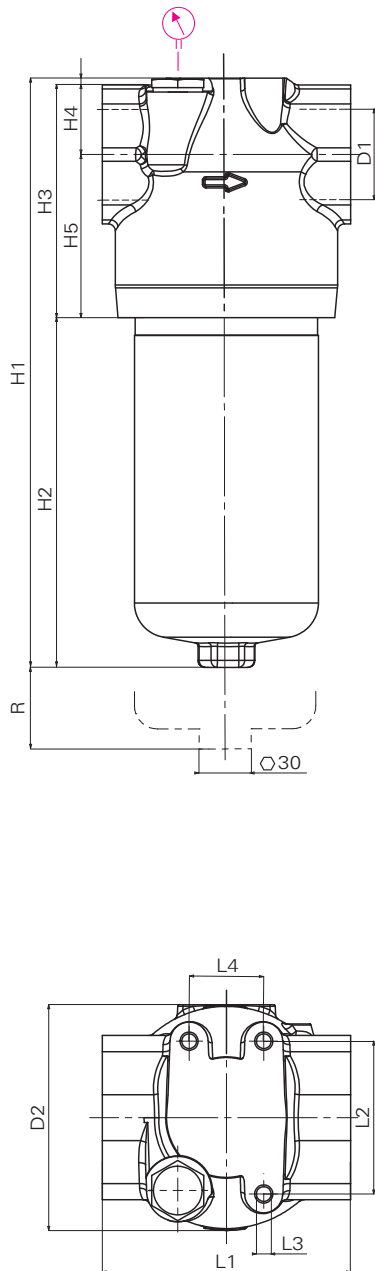

FPB 34-35

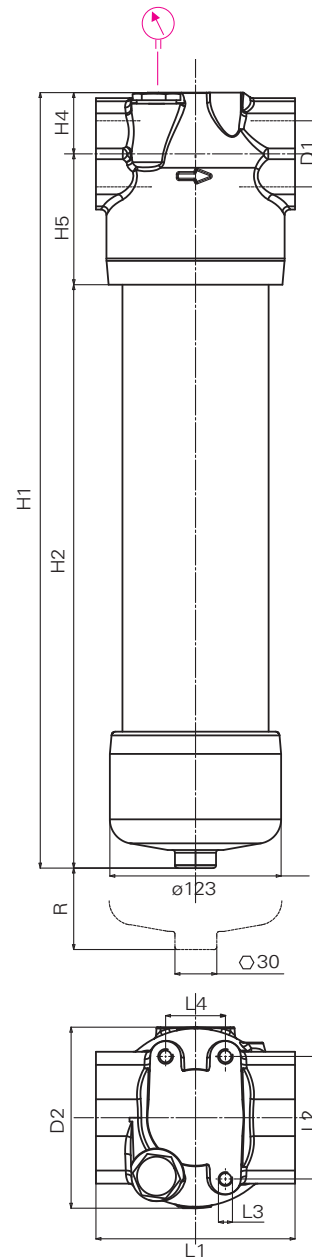

## FILTER HOUSING

	D1	D2	H1	H2	H3	H4	H5	L1	L2	L3	L4	R	kg
FPB31	1" - 1" 1/4 - 1" 1/2	128	245	107	138	44	94	143	88	M10	43	100	11,0
FPB32	1" - 1" 1/4 - 1" 1/2	128	337	199	138	44	94	143	88	M10	43	100	13,9
FPB33	1" - 1" 1/4 - 1" 1/2	128	457	319	138	44	94	143	88	M10	43	100	17,2
FPB34	1" - 1" 1/4 - 1" 1/2	128	558	420	138	44	94	143	88	M10	43	100	22,0
FPB35	1" - 1" 1/4 - 1" 1/2	128	658	520	138	44	94	143	88	M10	43	100	25,0

		<b>TYPE</b>						
		F = FILTER COMPLETE	F	F	F	F	F	
		B = FILTER HOUSING	B	B	B	B	B	<b>ELEMENT</b> E
P	B	<b>FAMILY, SIZE &amp; LENGTH</b>					<b>FAMILY SIZE &amp; LENGTH</b> P B	
			31	32	33	34	35	
		<b>PORT TYPE</b>						
		B = BSP - thread	B	B	B	B	B	
		N = NPT - thread	N	N	N	N	N	
		S = SAE - thread	S	S	S	S	S	
		F = SAE Flange 3000 psi	F	F	F	F	F	
		G = SAE Flange 6000 psi	G	G	G	G	G	
		<b>PORT SIZE</b>						
		08 = 1" (G08 and F08 not available)	08	08	08	08	08	
		10 = 1" 1/4 (N10 not available)	10	10	10	10	10	
		12 = 1" 1/2 (G12 option not available)	12	12	12	12	12	
		<b>BYPASS VALVE</b>						
		W = without	W	W	W	W	W	} on request only
		C = 600 kPa (6 bar)	C	C	C	C	C	
		R = reverse flow valve	R	R	R	R	R	
		P = reverse flow + bypass valve	P	P	P	P	P	
		<b>SEALS</b>					<b>SEALS</b>	
		N = NBR Nitrile	N	N	N	N	N	N = NBR
		F = FKM Fluoroelastomer	F	F	F	F	F	F = FKM
		<b>FILTER MEDIA</b>					<b>FILTER MEDIA</b>	
		FA = fiber 5 μm <sub>e</sub> β>1.000 Δp 2MPa (20 bar)	FA	FA	FA	FA	FA	FA = fib. 5μm <sub>e</sub> 20 bar
		FB = fiber 7 μm <sub>e</sub> β>1.000 Δp 2MPa (20 bar)	FB	FB	FB	FB	FB	FB = fib. 7μm <sub>e</sub> 20 bar
		FC = fiber 12 μm <sub>e</sub> β>1.000 Δp 2MPa (20 bar)	FC	FC	FC	FC	FC	FC = fib. 12μm <sub>e</sub> 20 bar
		FD = fiber 21 μm <sub>e</sub> β>1.000 Δp 2MPa (20 bar)	FD	FD	FD	FD	FD	FD = fib. 21μm <sub>e</sub> 20 bar
		HA = fiber 5 μm <sub>e</sub> β>1.000 Δp 21MPa (210 bar)	HA	HA	HA	HA	HA	HA = fib. 5μm <sub>e</sub> 210 bar
		HB = fiber 7 μm <sub>e</sub> β>1.000 Δp 21MPa (210 bar)	HB	HB	HB	HB	HB	HB = fib. 7μm <sub>e</sub> 210 bar
		HC = fiber 12 μm <sub>e</sub> β>1.000 Δp 21MPa (210 bar)	HC	HC	HC	HC	HC	HC = fib. 12μm <sub>e</sub> 210 bar
		HD = fiber 21 μm <sub>e</sub> β>1.000 Δp 21MPa (210 bar)	HD	HD	HD	HD	HD	HD = fib. 21μm <sub>e</sub> 210 bar
		CC = cellulose 10 μm β>2 Δp 2MPa (20 bar)	CC	CC	CC	CC	CC	CC = cel. 10 μm 20 bar
		<b>CLOGGING INDICATORS</b>						
		03 = port, plugged	03	03	03	03	03	When the filter is ordered with FKM seals, the first digit of the indicator code is a letter (please see page 182 - 183).
		5E = visual differential 500 kPa (5 bar)	5E	5E	5E	5E	5E	
		5F = visual differential 800 kPa (8 bar)	5F	5F	5F	5F	5F	
		6E = electrical differential 500 kPa (5 bar)	6E	6E	6E	6E	6E	
		6F = electrical differential 800 kPa (8 bar)	6F	6F	6F	6F	6F	
		7E = indicator 6E with LED	7E	7E	7E	7E	7E	
		7F = indicator 6F with LED	7F	7F	7F	7F	7F	
		T2 = elect. diff. 500 kPa (5 bar) with thermostat 30°C	T2	T2	T2	T2	T2	
		T3 = elect. diff. 800 kPa (8 bar) with thermostat 30°C	T3	T3	T3	T3	T3	
		<b>ACCESSORIES</b>						
X	X	XX = no accessory available	XX	XX	XX	XX	XX	N.B. Indicator series 72 & 73 only on request

**FILTER ELEMENT**

	A	B	C	kg media F+ & C+	kg media H+	Area (cm <sup>2</sup> )		
						Media F+	Media H+	Media C+
EPB31	78	42,5	118	0,40	0,70	2.000	1.470	1.720
EPB32	78	42,5	210	0,80	1,30	3.695	2.695	3.170
EPB33	78	42,5	330	1,00	1,60	5.025	4.325	4.025
EPB34	78	42,5	430	1,20	1,80	6.585	5.685	6.585
EPB35	78	42,5	530	1,40	2,00	8.145	7.045	8.645

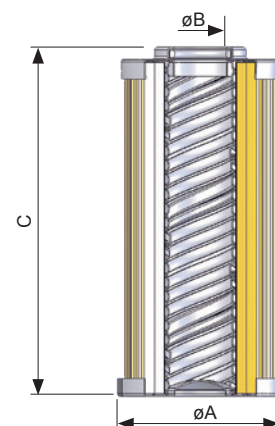

### FLUID SPEED

when selecting the filter size, we suggest to consider also the max recommended fluid speed (in pressure lines normally  $5 < v < 10$  m/s).

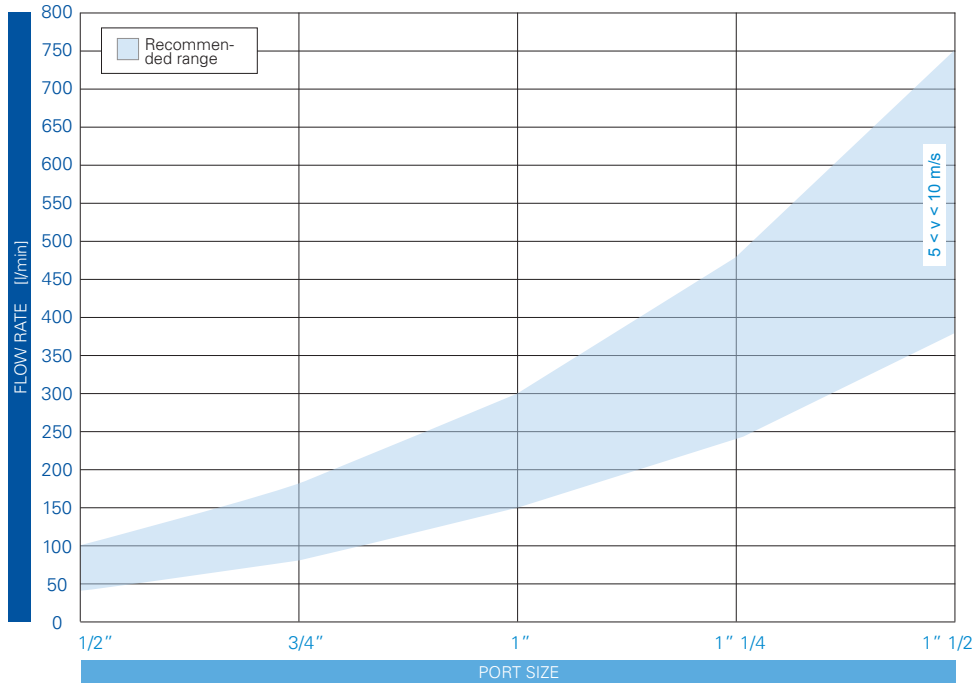

### PRESSURE DROP CURVES ( $\Delta p$ )

The "Assembly Pressure Drop ( $\Delta p$ )" is obtained by adding the pressure drop values of the Filter Housing and of the Clean Filter Element corresponding to the considered Flow Rate and it must be lower than 120 kPa (1,2 bar).

#### FILTER HOUSING PRESSURE DROP (mainly depending on the port size)

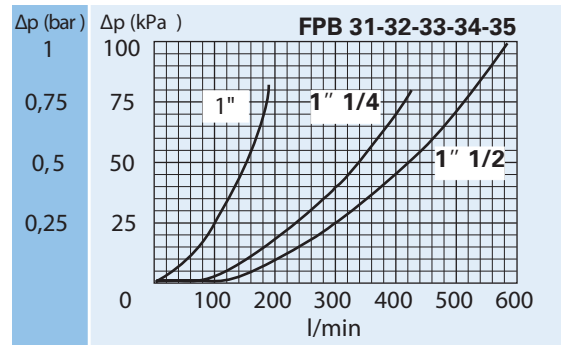
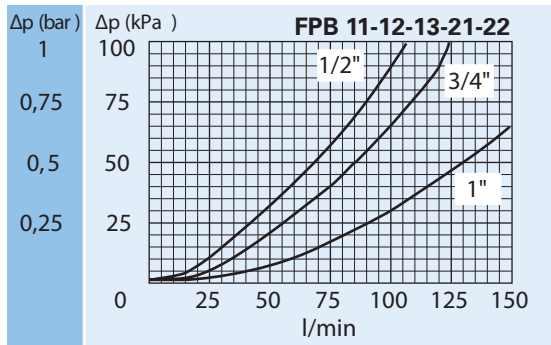

#### CLEAN FILTER ELEMENT PRESSURE DROP WITH F+ AND C+ MEDIA (depending both on the internal diameter of the element and on the filter media)

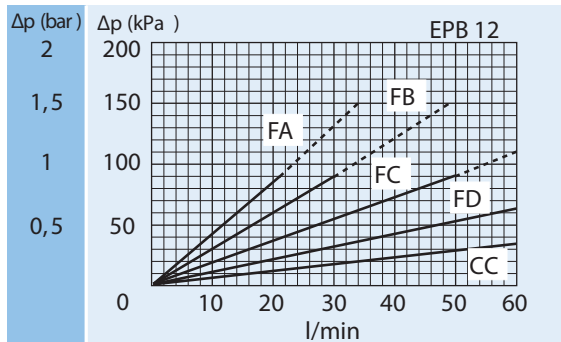
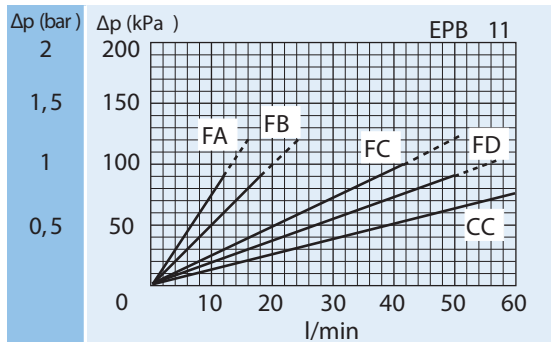

**CLEAN FILTER ELEMENT PRESSURE DROP WITH F+ AND C+ MEDIA**  
 (depending both on the internal diameter of the element and on the filter media)

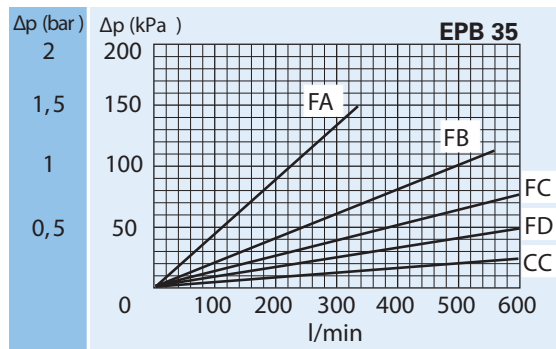
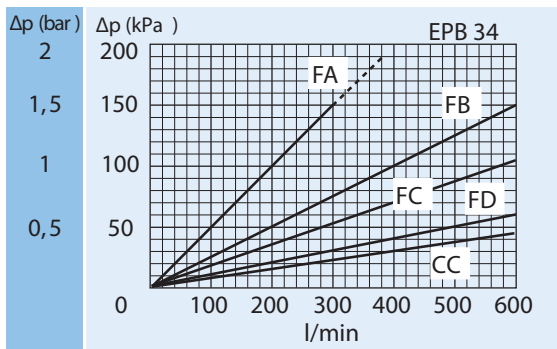
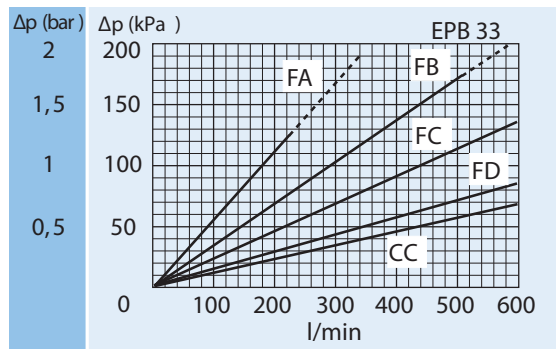
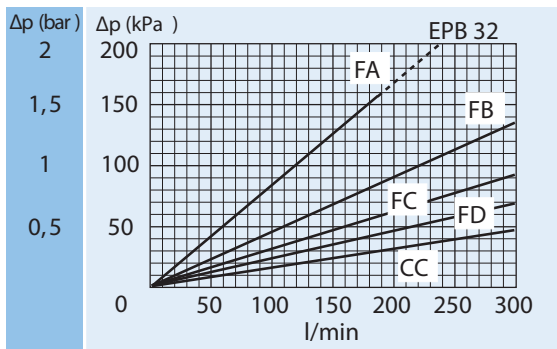
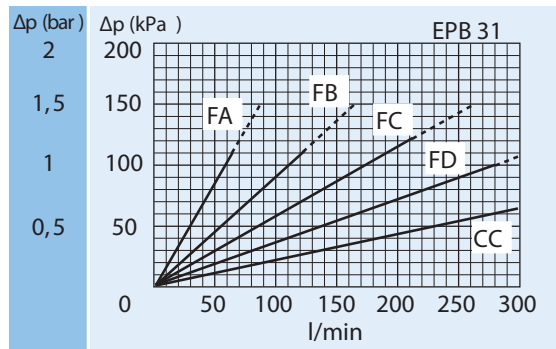
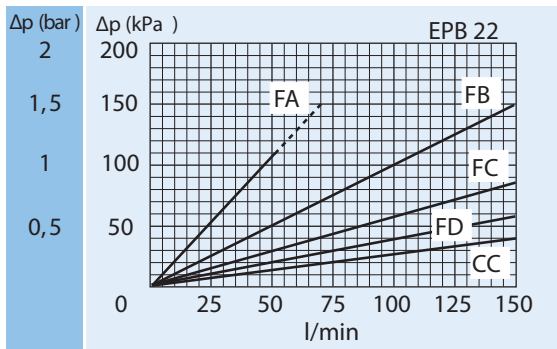
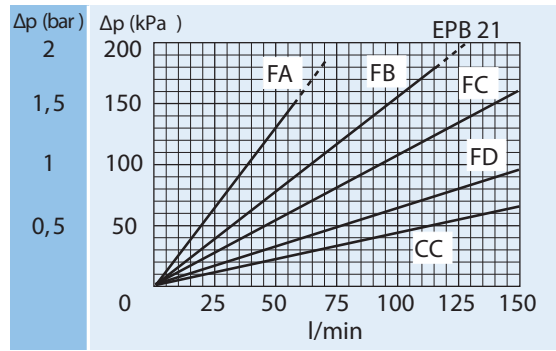
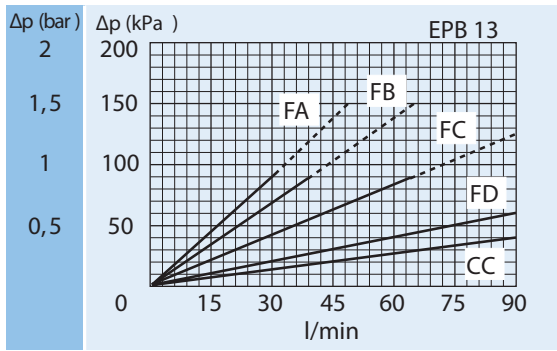

N.B. All the curves have been obtained with mineral oil having a kinematic viscosity 30 cSt and specific gravity 0,9 kg/dm<sup>3</sup>; for fluids with different features, please consider the factors described in the first part of this catalogue.



## PRESSURE DROP CURVES ( $\Delta p$ )

The "Assembly Pressure Drop ( $\Delta p$ )" is obtained by adding the pressure drop values of the Filter Housing and of the Clean Filter Element corresponding to the considered Flow Rate and it must be lower than 120 kPa (1,2 bar).

### CLEAN FILTER ELEMENT PRESSURE DROP

(depending both on the internal diameter of the element and on the filter media)

#### WITH H+ MEDIA

(recommended with no bypass option)

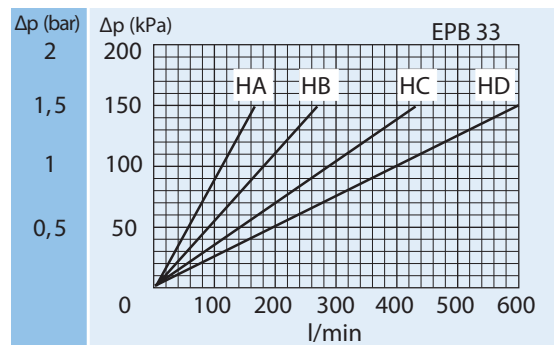
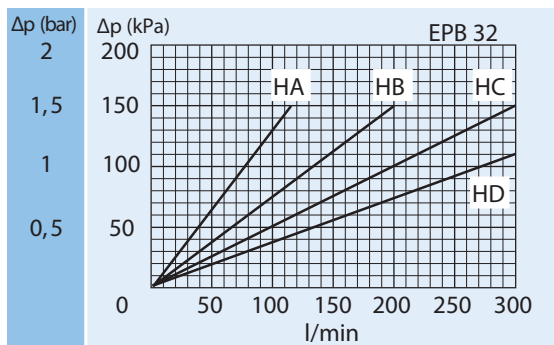
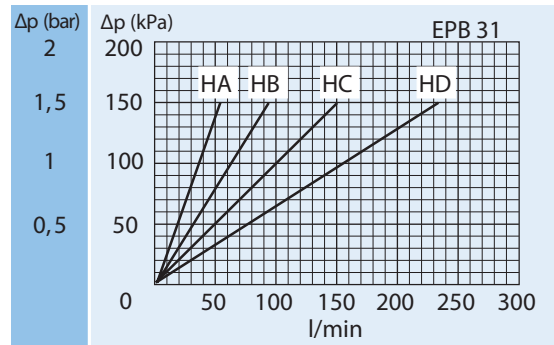
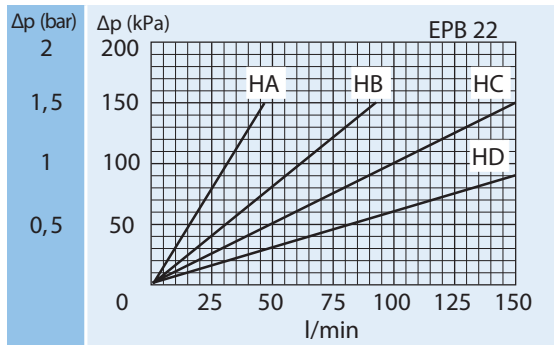
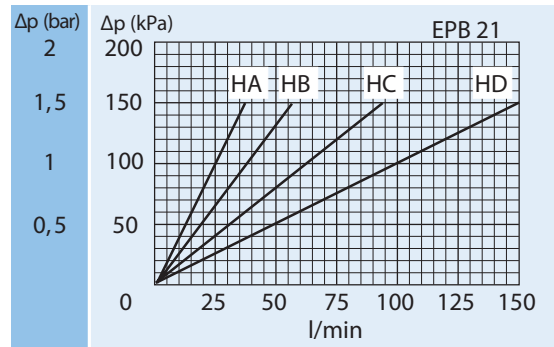
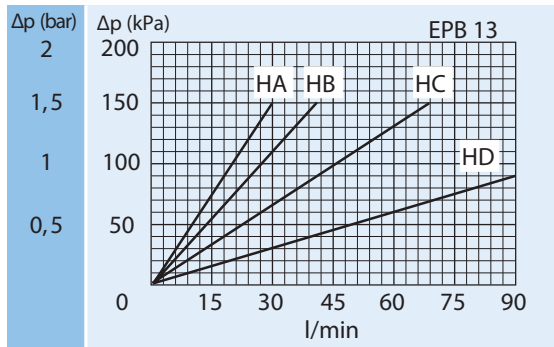
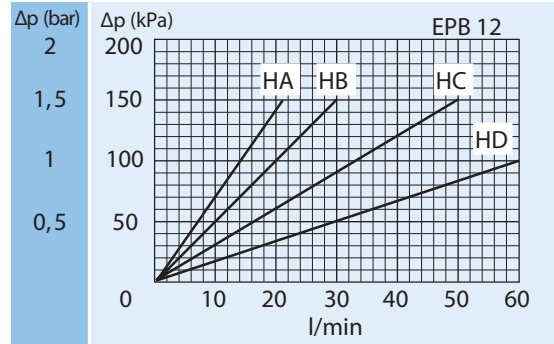
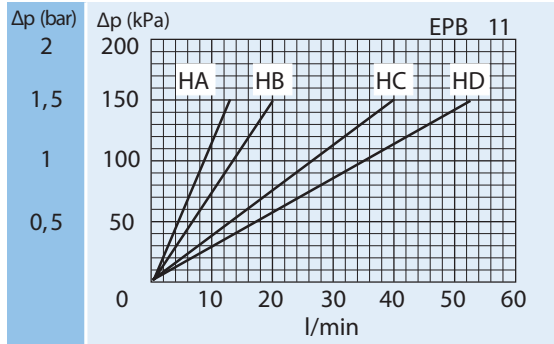



**CLEAN FILTER ELEMENT PRESSURE DROP**

(depending both on the internal diameter of the element and on the filter media)

**WITH H+ MEDIA**

(recommended with no bypass option)

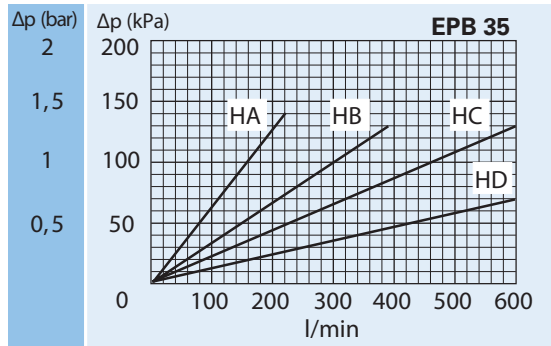
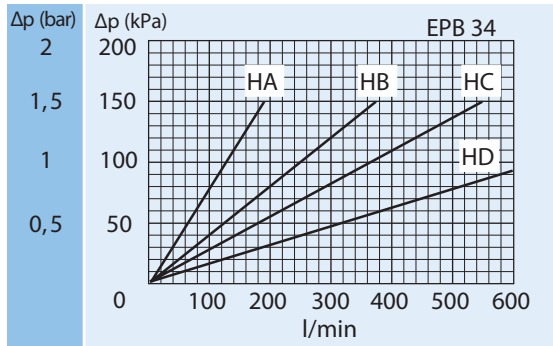

**BYPASS VALVE PRESSURE DROP**

When selecting the filter size, these curves must be taken into account if it is foreseen that any flow peak is to be absorbed by the bypass valve, it also must be of proper configuration to avoid pressure peaks. The valve pressure drop is directly proportional to fluid specific gravity.

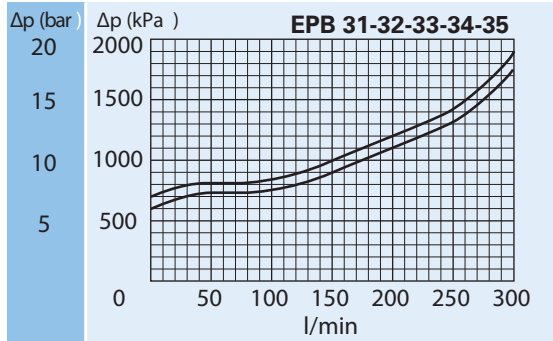
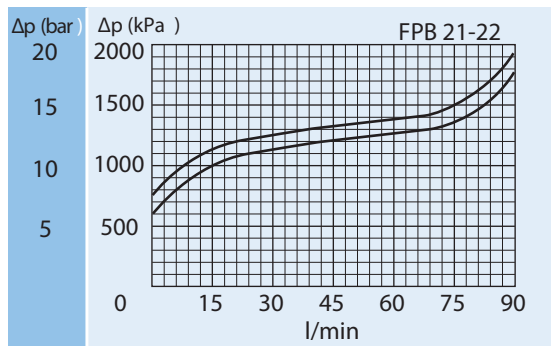
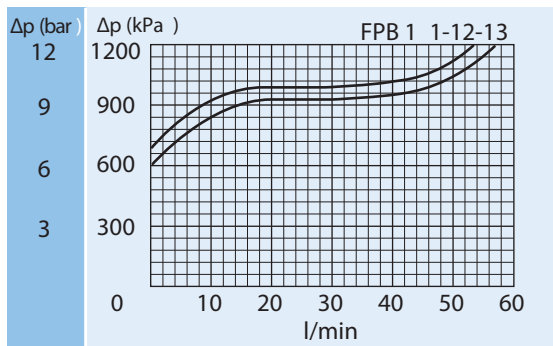

N.B. All the curves have been obtained with mineral oil having a kinematic viscosity 30 cSt and specific gravity 0,9 kg/dm<sup>3</sup>; for fluids with different features, please consider the factors described in the first part of this catalogue. All the curves are obtained from test done at the UFI HYDRAULIC DIVISION Laboratory, according to the specification ISO 3968:2005. In case of discrepancy, please check the contamination level, viscosity and features of the fluid in use.

**REVERSE FLOW VALVE**

**NORMAL FLOW**

**REVERSE FLOW**

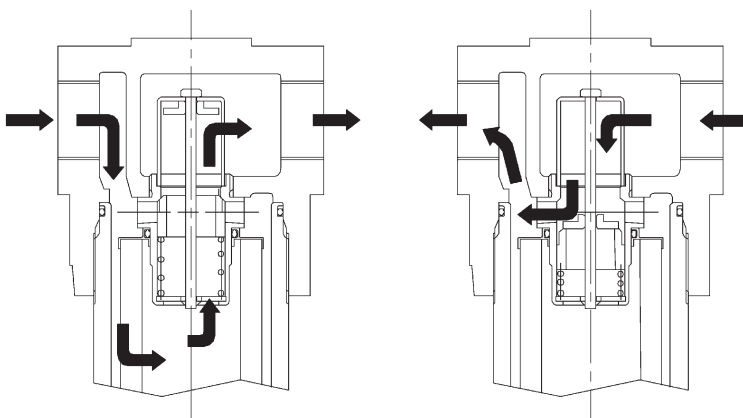

For hydraulic systems where reverse flow can occur, the pressure filters series FPB2+ and FPB3+ are available with a free reverse flow valve allowing the fluid to pass through the filter element in the normal direction and to bypass the filter element in the reverse direction (option "R"). The reverse flow valve is available also with incorporated bypass valve for the normal flow direction, set at 6 bar (option "P").

In normal flow conditions the whole flow pass through the filter element. In the option "P", if the differential pressure across the element exceeds 6 bar the bypass is activated.

In reverse flow conditions the flow bypasses the filter element.

**Pressure drop through the valve in the reverse direction:**

- 0,4 bar at 100 L/min
- 0,6 bar at 200 L/min
- 0,8 bar at 300 L/min

